

# ROHR2

Program System ROHR2  
Interfaces - Overview and Details

SIGMA Ingenieurgesellschaft mbH



## Content

	<b>ROHR2 Introduction.....</b>	<b>1</b>
<b>1</b>	<b>ROHR2 interfaces.....</b>	<b>1</b>
1.1	ROHR2 Interfaces overview.....	2
1.2	Licenses and system requirements.....	3
<b>2</b>	<b>Interfaces to CAD-Systems .....</b>	<b>4</b>
2.1	Neutral CAD Interface ROHR2.....	5
2.2	Alternative Data formats.....	6
2.2.1	Interfaces to CAD-Systems .....	6
2.2.2	Interfaces for the conversion of piping structures.....	8
<b>3</b>	<b>CAE Interfaces.....</b>	<b>9</b>
3.1	Pipe stress analysis software interfaces .....	9
3.1.1	ROHR2 Import .....	9
3.1.2	ROHR2 Export .....	9
3.2	Fluid dynamics interfaces.....	9
3.2.1	Pressure loss .....	9
3.2.2	Fluid dynamics .....	10
<b>4</b>	<b>ROHR2 Results Export .....</b>	<b>11</b>
4.1	Support data.....	11
4.1.1	Export of general support data .....	11
4.1.2	Manufacturer specific software formats.....	11
4.2	CAD Export .....	12
4.2.1	Export to E3D/ PDMS.....	12
4.2.2	NTR and PCF-Export .....	12
4.3	Export of graphics .....	13

Rel.20.02

## 1 ROHR2 interfaces

A comprehensive number of interface modules is part of the ROHR2 standard package. Optional interfaces are available to integrate ROHR2 into your workflow.

This document shows an overview on the interfaces, available with ROHR2 and their application. Please contact us concerning the optimization of your workflow with ROHR2. Our support team would be pleased to provide you with detailed parameter listings and the integration of third party products.

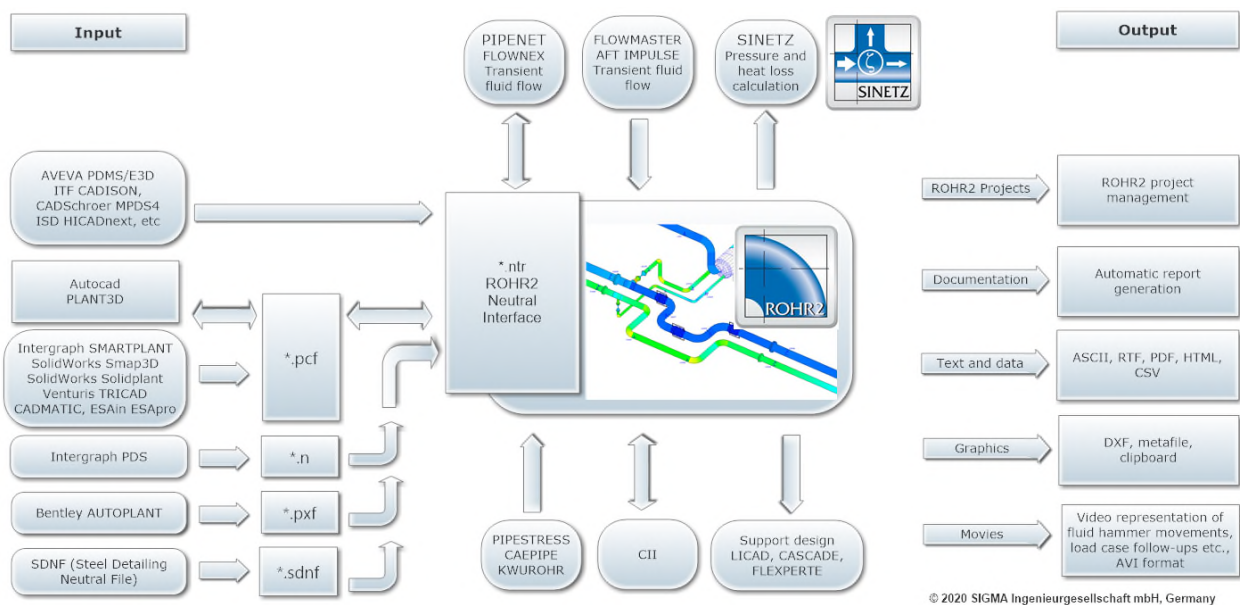

ROHR2 Interfaces, Standard equipment and optional modules

# ROHR2

connecting

# CAD/CAE

with

# Calculation

The integration of ROHR2 is supported by third-party interface products. In case of questions or information requests, please contact the manufacturer. We will be pleased to advise you regarding the data import and export to ROHR2. For updated information and links to software companies please refer to [www.rohr2.com](http://www.rohr2.com).

Please note: the integration of external interfaces may require an upgrade of the program system ROHR2: the ROHR2 Neutral Interface is the main program module for the integration of CAD-programs.



### 1.1 ROHR2 Interfaces overview

ROHR2 available interfaces - Overview	Import / Export	Standard package	Optional available interfaces
Neutral Interface ROHR2 with PDMS/E3D data exchange	IMP	X	
	EXP	X	
DXF data import	IMP	X	
CSV Geometry data import	IMP	X	
Support data Interface	EXP	X	
LICAD, CASCADE, FLEXPORTE	EXP	X	
E3D (PDMS)	IMP	X	
	EXP	X	
<b>ROHR2 – Pressure loss, fluid dynamics</b>			
SINETZ Pressure loss	EXP	X	
Fluid flow calculation, CFD (PIPENET, FLOWNEX, etc.)	IMP	X	
	EXP	X	
*.FRC Import of Load-time courses, e.g. Flowmaster, AFT Impulse	IMP	X	
*.CSV Import of Load-time functions,	IMP	X	
<b>ROHR2 – CAE systems transfer</b>			
CAEPIPE	IMP	X	
PIPESTRESS	IMP	X	
CAESAR II	IMP	X	
	EXP		X
KWUROHR (Siemens)	IMP	X	
<b>ROHR2 CAD interface package, includes</b>			
PCF pipe component file (*.pcf)	IMP		X
	EXP		X
PDS	IMP		X
PASCE	IMP		X
AUTOPLANT/AUTOPIPE PXF	IMP		X
SDNF (structural steel)	IMP		X
PLANT3D data	IMP		X



### ***Interfaces in the ROHR2 standard package***

The interfaces are part of the ROHR2 standard package.

### ***Optional Interfaces***

Optional interfaces are not part of the ROHR2 standard configuration.

## **1.2 Licenses and system requirements**

### ***Program version, network license***

The interfaces are included or optional available modules in the program system ROHR2. They can be part of the ROHR2 single user license and ROHR2 network license. In the ROHR2 network license the number of the users of an interface module is always similar to the number of ROHR2 network seats.

The system requirements are similar to those of the ROHR2 program (see ROHR2 Specification).

Interfaces are part of the ROHR2 user interface.

## 2 Interfaces to CAD-Systems

The data for generating a pipe model in ROHR2 is done by importing files from 3D Plant engineering systems by integrated interfaces (some of them optionally available).

The import process is not working on the basis of simple graphic data but on integrated component databases or database reports. This enables to get more information than a simple piping structure, like assignment of materials, dimensions or support positions, required for the modeling in the ROHR2 pipe stress calculation ROHR2

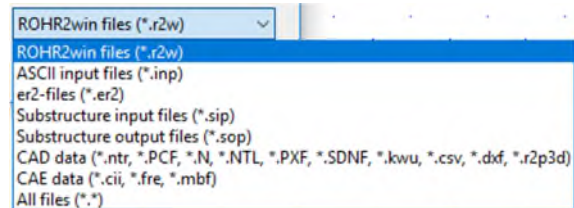

The ROHR2 Neutral Interface is the main program module for the integration of CAD-programs. The import is made by two steps:

- transfer into the neutral file format
- conversion into the ROHR2 input format.

The neutral interface is part of the current ROHR2 standard package or available as an upgrade.

Use the command *FILE| OPEN* to select one or more files of the same type. A project is generated containing the imported data of all selected files.

### Scope of transferred data

Automatic generation of the ROHR2 input data from CAD-systems, in detail (if available):

- Geometry data
- Diameter, Wall thickness`
- Materials
- Support points and support conditions
- Tees
- Instruments, flanges
- Expansion joints
- Reducers
- Design data, operation data

Enables automatic generation of the load cases dead weight, medium weight and operation.

Stresses and loads can be determined according to the calculation standard.

The conversion volume depends on the quantity and quality of the imported data. The quantity and quality of the imported data depends on the capability of the exporting CAD/CAE software. In many times there are opportunities to configure the export capabilities at the source.

## 2.1 Neutral CAD Interface ROHR2

To simplify the data interchange with CAD systems, the format of the neutral interface was defined. Being based on the listing of all elements in the system (pipe, bend, instruments, supports, ...) it can be created e.g. by a report from a database.

For each element parameters required by ROHR2 have to be indicated.

Only a part of the parameters must be entered by the user, not indicated parameters are filled with standard values or calculated from other parameters. The elements are written into an ASCII file as data sets with defined record label and corresponding parameters.

These CAD-Systems are creating data in the format of the Neutral interface enabling the direct data import into ROHR2:

- AVEVA E3D/PDMS
- CADISON NEILSOFT (ITF)
- RC-Planet (Planet GmbH),
- MPDS4 (CAD Schroer),
- HICAD (ISD GmbH), ea.

The ROHR2 standard package includes the import of data in NTR format from AVEVA PDMS/E3D using the ROHR2 neutral interface.

On the part of the CAD/CAE system optional modules may be required for the generation of an export file in Neutral file format

Identifier for the support type			
Identifier	Description	Support direction	Remarks
FP	Fixed point	all movements and torsions	Friction, gap of support not considered
GL	Slide bearing	vertical	
FL	Guide bearing, ledger	vertical, transverse	
AX	axial stop	axial	
QS	Transverse stop	horizontally transverse	
GLAX	Slide bearing with axial stop	vertical, axial	
FLAX	Ledger with axial stop	all movements	
QSAX	Transverse and axial stop	horizontally transverse, axial	
FLVX	Guide support in vertical direction, bearing in global x-axis	vertical, transverse to Xa	vertical segments only, X must NOT be vertical axis.
FLVY	Guide support in vertical direction, bearing in global y-axis	vertical, transverse to Ya	vertical segments only, Y must NOT be vertical axis.
FLVZ	Guide support in vertical direction, bearing in global z-axis	vertical, transverse to Za	vertical segments only, Z must NOT be vertical axis.
FLVXY	Guide support in vertical direction, bearing in global x- and y-axis	vertical, transverse to Xa and Ya	vertical segments only, Z must be vertical axis.
FLVXZ	Guide support in vertical direction, bearing in global x- and z-axis	vertical, transverse to Xa and Za	vertical segments only, Y must be vertical axis.
FLVYZ	Guide support in vertical direction, bearing in global y- and z-axis	vertical, transverse to Ya and Za	vertical segments only, X must be vertical axis.
QSV	Transverse stop in vertical piping	both transverse directions	vertical segments only
QSVX	Transverse stop in vertical piping in global x-axis	transverse in Xa	vertical segments only, X must NOT be vertical axis.
QSVY	Transverse stop in vertical piping in global y-axis	transverse in Ya	vertical segments only, Y must NOT be vertical axis.
QSVZ	Transverse stop in vertical piping in global z-axis	transverse in Za	vertical segments only, Z must NOT be vertical axis.



## 2.2 Alternative Data formats

Interfaces listed here are part of the ROHR2 CAD Interface package.  
All interfaces mentioned here use the data transfer into the Neutral file Format (see 2.1) as a first step.  
The ROHR2 neutral interface is required part of the process and included in the current standard program configuration ROHR2.

The integration of ROHR2 is supported by third-party interface products.

### 2.2.1 Interfaces to CAD-Systems

#### ROHR2 CAD interface package

ROHR2 CAD interfaces are available in an optional CAD package which contains the modules

- PCF - ROHR2
- Intergraph PDS - ROHR2
- AUTOPLANT PXF- ROHR2
- PASCE - ROHR2
- SDNF – ROHR2 (structural steel)

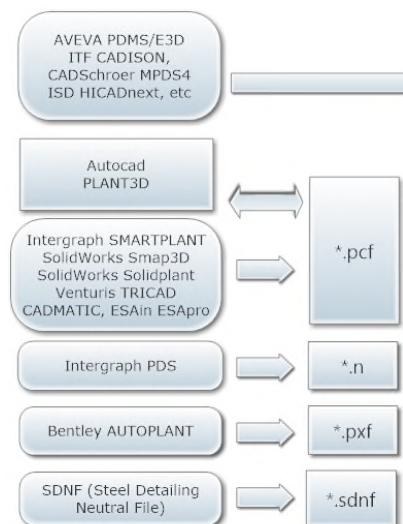
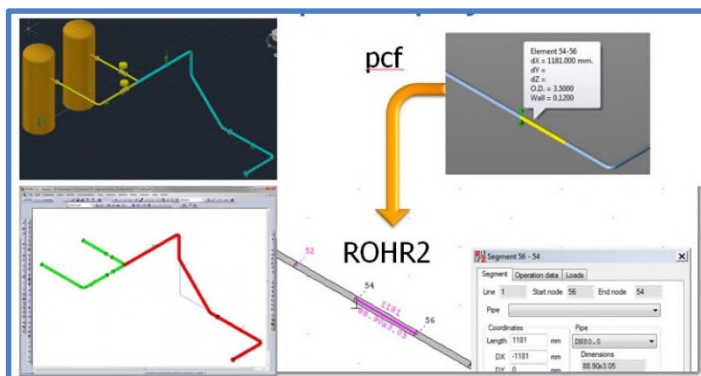

© 2020 SIGMA Ingenieurgesellschaft mbH, G

PCF – ROHR2 Import via Neutral Interface

The PCF format is used by several CAD-systems to create isometrics like AUTODESK Plant3D, Intergraph SMARTPLANT or Pro/ENGINEER.

The PCF interface is used to convert data from various CAD systems into ROHR2 and to export ROHR2 system data in \*.pcf format (export see 4.2.2)

The interfaces can be adapted individually to the imported data using configuration files.

### Customize pcf import

Assignments can be defined for these data types:

Data type	Parameter name in pcf.env	Standard Attribute in PCF	Optional Attribute In PCF
Material	Att_Mat		Component-Attribute10
Wall thickness 1 - 4	Att_WallThk1, Att_WallThk2 Att_WallThk3 Att_WallThk4		Component-Attribute11
Insulation thickness	Att_IsThk		Component-Attribute12
Operation temperature	Att_TempOper	PIPELINE-TEMP	
Operation pressure	Att_PressOper		Component-Attribute13
Design temperature	Att_TempDesign		Component-Attribute14
Design pressure	Att_PressDesign		Component-Attribute15
Medium density	Att_RhoMed		Component-Attribute16
weight	Att_Weight	WEIGHT	
Type of Support	Att_SupType	SKEY	

Add individual component attributes to complete data for ROHR2 export

Example of a pcf configuration table

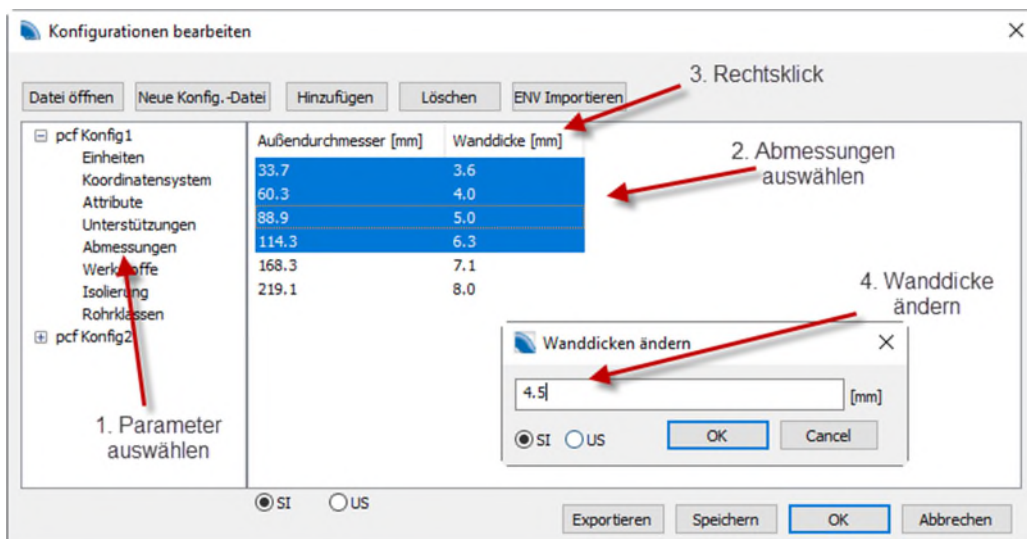

Figure 1 Changing multiple data

The PCF Configurator can be used to create and manage configurations for translating PCF files. For translation the PCF attributes are assigned to the appropriate ROHR2 attributes.

## 2.2.2 Interfaces for the conversion of piping structures

The creation of a piping model by means of graphics data information (e. g. AUTOCAD \*.dwg) allows to generate a geometry model in best case. ROHR2 does not support this working method, because modeling in ROHR2win is the more efficient way to get a piping model. These interfaces are included in the ROHR2 standard package

### 3D DXF data import

Generate a ROHR2 model from 3D isometrics in DXF format (\*.dxf)  
All types of lines („LINE“, „POYLINE“, „LWPOLYLINE“) are used to generate ROHR2 segments.  
Select the layers which need to be considered.

### CSV import interface – Reading geometry data from text files

The interface CSV is used to convert data in text format (\*.csv - comma separated value) into a format readable by ROHR2.

This way piping structures can be generated to get a ROHR2 project piping model. Parameters, relevant for the calculation need to be added in the ROHR2 project.

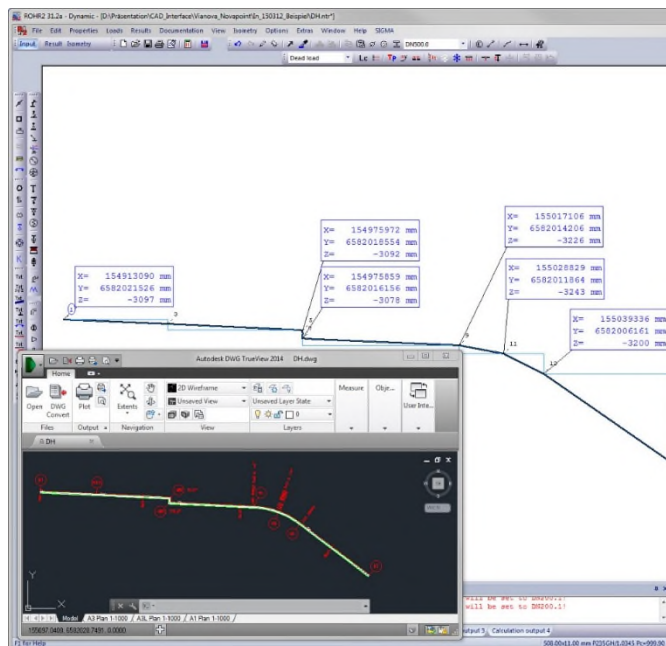

ROHR2 piping model basing on node coordinates



## 3 CAE Interfaces

### 3.1 Pipe stress analysis software interfaces

#### 3.1.1 ROHR2 Import

<b>CAESAR II Interface</b>	Import of data from Neutral File Format (*.cii). from Caesar II (Intergraph Corporation)
<b>CAEPIPE Interface</b>	Import of data from model batch files (*.mbf) from CAEPIPE (SST Systems INC.)
<b>PIPESTRESS Interface</b>	Import of data from model batch files (*.fre). from PIPESTRESS (DST Computer Services S.A.).
<b>KWUROHR Interface</b>	Import of data in format *.kwu data from KWUROHR (SIEMENS)

The interface is used for the data import from pipe stress analysis software.  
Part of the imported data are the piping model as well as load case parameters.  
The range of the imported data is documented comprehensively in the interface manuals.

#### 3.1.2 ROHR2 Export

<b>CAESAR II Export interface</b>	Export of data into the Caesar II Neutral File Format to be used in Caesar II (Intergraph Corporation)
-----------------------------------	---

The interfaces are used for the data export to Caesar II. Part of the imported data is the piping model as well as load case parameters.  
For details please refer to the separate manual, which is part of the interface software.

### 3.2 Fluid dynamics interfaces

#### 3.2.1 Pressure loss

<b>SINETZ Interface</b>	<b>Export of calculation models into SINETZ</b> (Product of SIGMA Ingenieurgesellschaft mbH)
-------------------------	---

The SINETZ program includes a neutral interface to import data from CAD/CAE programs. It enables to import geometry data, dimensions, insulation, components like bends, instruments, pumps, reducers and orifices as well as boundary conditions (pressure, temperature and quantities).



### 3.2.2 Fluid dynamics

#### General Fluid dynamic data exchange

##### Interface Fluid dynamic programs Import of load - time-functions

##### Import of fluid hammer forces into ROHR2

For the conversion of load-time functions from various fluid dynamic software ROHR2 provides an import capability. ROHR2 converts \*.frc and \*.csv-files or ASCII files into a proprietary ROHR2 binary format.

The interface is used for the data transfer from software products like

- PIPENET Transient
- Flownex
- DRAKO
- INROS
- FLOWMASTER
- AFT Impulse

Additional program systems upon request

#### Fluid dynamic systems PIPENET TRANSIENT and FLOWNEX

##### PIPENET TRANSIENT and FLOWNEX import and export interfaces

Interface for the exchange of data between ROHR2 and fluid dynamic software products

- PIPENET Transient (Sunrise Systems Ltd, [www.sunrise-sys.com](http://www.sunrise-sys.com)).
- FLOWNEX ([www.flownex.com](http://www.flownex.com)).

##### File transfer and calculation process

- The entire ROHR2 model is converted into the format of the fluid dynamic system.
- At deflections, branches and reductions in the ROHR2 model force vectors will be generated, assigned and exported.
- The calculation of the time-dependent forces is carried out in the fluid hammer software.
- Load -time functions (dynamic fluid hammer forces) can be transferred to ROHR2 and assigned automatically
- The fluid hammer analysis of the piping framework can be carried out nearly without additional manual inputs, because the fluid hammer forces have been created by the fluid analysis programs.

The data exchange uses the file formats

- \*.sdf for PIPENET Transient
- \*.nts for FLOWNEX

## 4 ROHR2 Results Export

ROHR2 offers various data formats for the export of calculation results. The number of generated results contains general data as well as particular parameters to be transferred by manufacturer software tools.

### 4.1 Support data

#### 4.1.1 Export of general support data

Data of all supports may be exported for further treatment. The export file is a fixed-format text file including calculated results. The file extension is \*.sup.

The interface CSV is used to convert data in text format (\*.csv) by ROHR2.

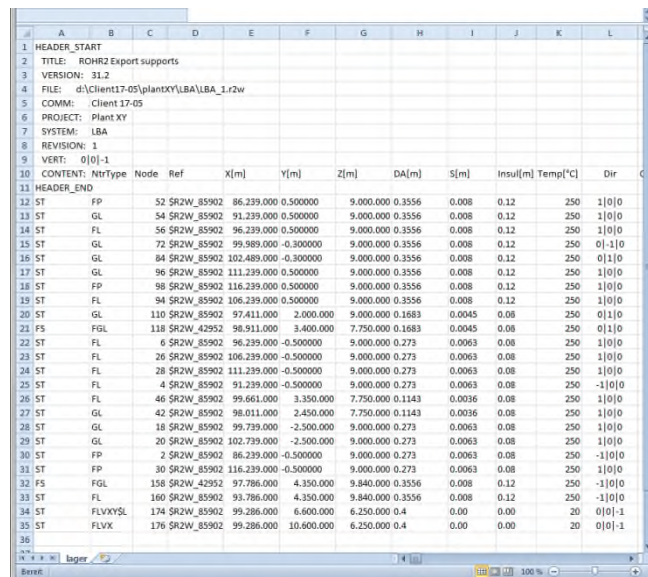

10	CONTENT:	NtrType	Node	Ref	X(m)	Y(m)	Z(m)	DA(m)	S(m)	Insul(m)	Temp[°C]	Dir
11	HEADER_END											
12	ST	FP	52	SRZW_85902	86.239.000	0.500000	9.000.000	0.3556	0.008	0.12	250	1 0 0
13	ST	GL	54	SRZW_85902	91.239.000	0.500000	9.000.000	0.3556	0.008	0.12	250	1 0 0
14	ST	FL	56	SRZW_85902	86.239.000	0.500000	9.000.000	0.3556	0.008	0.12	250	1 0 0
15	ST	GL	72	SRZW_85902	99.989.000	-0.300000	9.000.000	0.3556	0.008	0.12	250	0 -1 0
16	ST	GL	84	SRZW_85902	102.489.000	-0.300000	9.000.000	0.3556	0.008	0.12	250	0 1 0
17	ST	GL	96	SRZW_85902	111.239.000	0.500000	9.000.000	0.3556	0.008	0.12	250	1 0 0
18	ST	FP	98	SRZW_85902	116.239.000	0.500000	9.000.000	0.3556	0.008	0.12	250	1 0 0
19	ST	FL	94	SRZW_85902	106.239.000	0.500000	9.000.000	0.3556	0.008	0.12	250	1 0 0
20	ST	GL	110	SRZW_85902	97.411.000	2.000.000	9.000.000	0.1683	0.0045	0.08	250	0 1 0
21	FS	FGL	118	SRZW_42952	98.911.000	3.400.000	7.750.000	0.1683	0.0045	0.08	250	0 1 0
22	ST	FL	6	SRZW_85902	86.239.000	-0.500000	9.000.000	0.273	0.0063	0.08	250	1 0 0
23	ST	FL	26	SRZW_85902	106.239.000	-0.500000	9.000.000	0.273	0.0063	0.08	250	1 0 0
24	ST	FL	28	SRZW_85902	111.239.000	-0.500000	9.000.000	0.273	0.0063	0.08	250	1 0 0
25	ST	FL	4	SRZW_85902	91.239.000	-0.500000	9.000.000	0.273	0.0063	0.08	250	-1 0 0
26	ST	FL	46	SRZW_85902	99.661.000	3.350.000	7.750.000	0.1143	0.0036	0.08	250	1 0 0
27	ST	GL	42	SRZW_85902	98.011.000	2.450.000	7.750.000	0.1143	0.0036	0.08	250	1 0 0
28	ST	GL	18	SRZW_85902	99.739.000	-2.500.000	9.000.000	0.273	0.0063	0.08	250	1 0 0
29	ST	GL	20	SRZW_85902	102.739.000	-2.500.000	9.000.000	0.273	0.0063	0.08	250	1 0 0
30	ST	FP	2	SRZW_85902	86.239.000	-0.500000	9.000.000	0.273	0.0063	0.08	250	-1 0 0
31	ST	FP	30	SRZW_85902	116.239.000	-0.500000	9.000.000	0.273	0.0063	0.08	250	1 0 0
32	FS	FGL	158	SRZW_42952	97.786.000	4.350.000	9.840.000	0.3556	0.008	0.12	250	-1 0 0
33	ST	FL	160	SRZW_85902	93.786.000	4.350.000	9.840.000	0.3556	0.008	0.12	250	-1 0 0
34	ST	FLVXXSL	174	SRZW_85902	99.286.000	6.600.000	6.250.000	0.4	0.00	0.00	20	0 0 -1
35	ST	FLVX	176	SRZW_85902	99.286.000	10.600.000	6.250.000	0.4	0.00	0.00	20	0 0 -1
36												

ROHR2 Export Supports

#### 4.1.2 Manufacturer specific software formats

ROHR2 generates individually adapted export files to be used in the CAE systems:

- **LICAD (LISEGA GmbH)**
- **CASCADE und FLEPERTE (Witzenmann GmbH)**

For details of the data conversion please refer to the software documentation

## 4.2 CAD Export

### 4.2.1 Export to E3D/ PDMS

#### PDMS Interface ROHR2

In addition to the import of E3D/ PDMS data (see 2.1, Neutral interface) ROHR2 results can be exported into PDMS/E3D.

The data export from ROHR2 to PDMS/E3D includes load case dependent support results and deformations.

Deformed structures may be represented in E3D/PDMS this way. Beyond that, in E3D/PDMS calculation results are stored for further treatment, e.g. LICAD hanger design software.

### 4.2.2 NTR and PCF-Export

Export of ROHR2 models in various data formats.

#### **NTR Data export**

ROHR2 includes the export of Neutral File data. The export of NTR files (\*.ntr) is carried out by the ROHR2 command by *File| Export| Neutral interface*.

#### **PCF Data export**

The PCF - ROHR2 interface includes the export of ROHR2 system data in PCF format.

The export of data in PCF format (\*.pcf) is done in ROHR2win by the function *File| Export| PCF*.

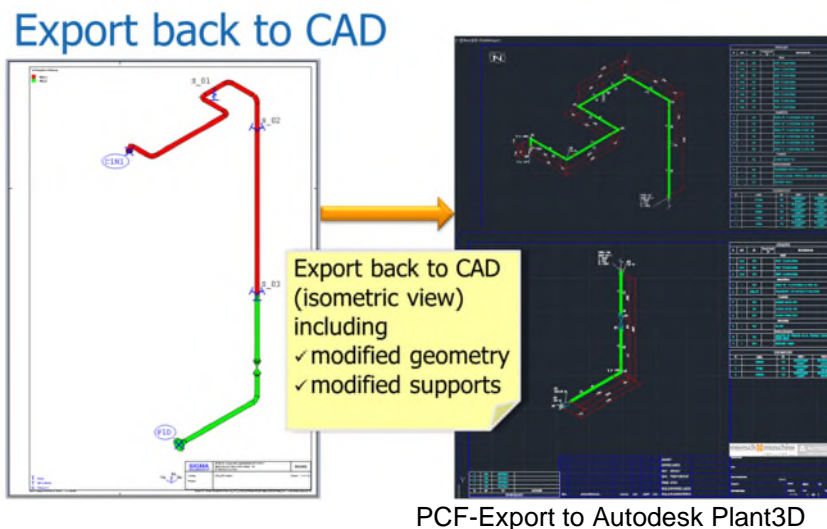

### 4.3 Export of graphics

#### **Export from ROHR2**

ROHR2 drawings can be exported into the file formats:

- Metafile (\*.emf)
- JPG
- DXF

The export into dxf format e.g. can be used for processing in AUTOCAD. The generated data is of 2D dxf drawing type with restricted modification capability.

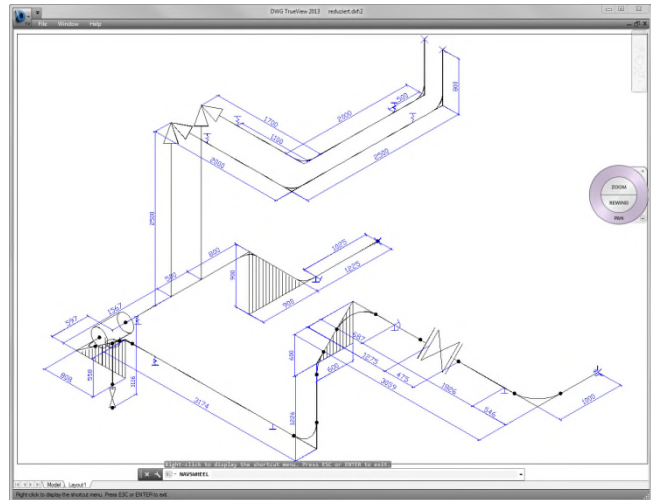

*ROHR2 DXF Export*